

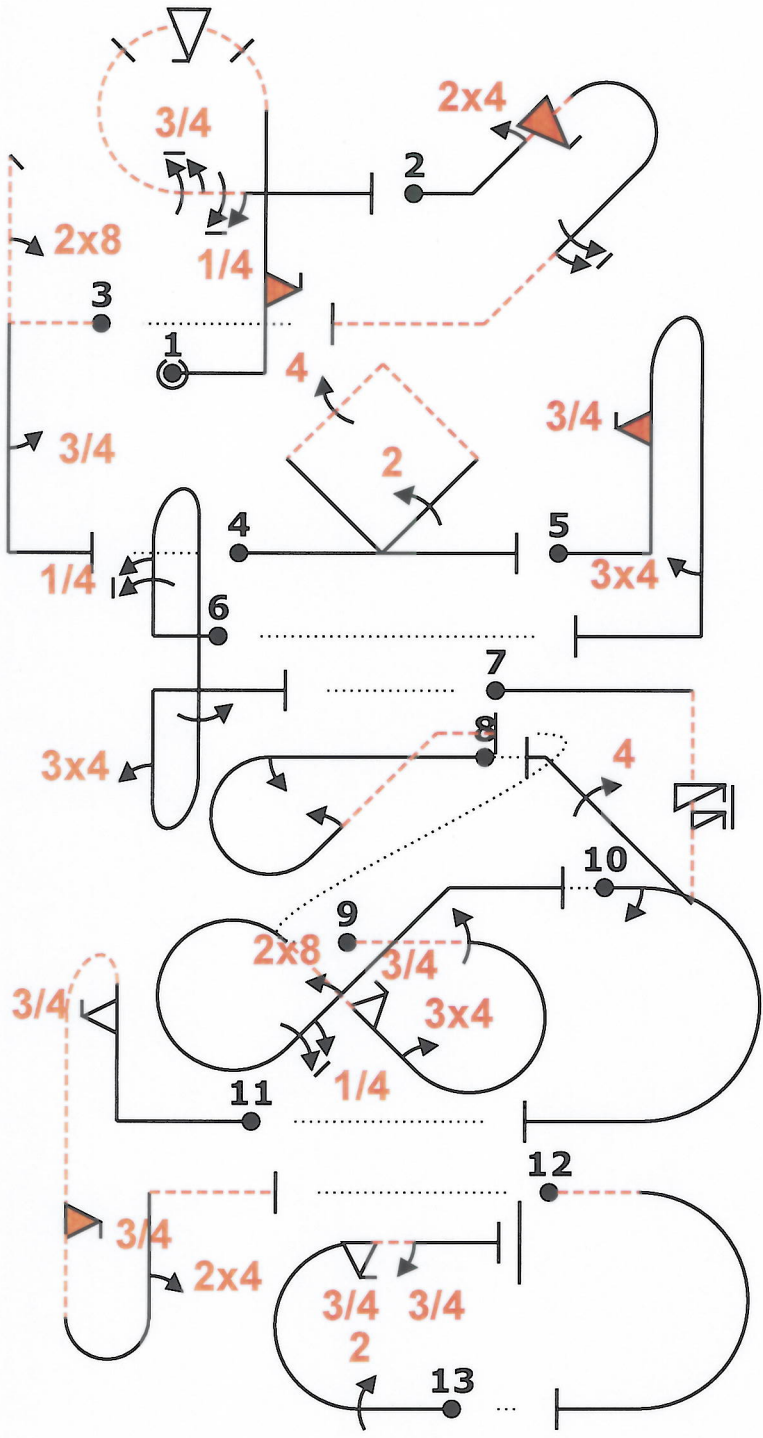

WAC 2024		Form B
Pilot ID	CIVA Unlimited Programme2	
		Flight #



Power			
Fig	Aresti	K	
1 B	8.6.4.1	14	66 /
	9.10.6.2	19	
	9.9.8.4	13	
	9.1.3.7	11	
	9.1.3.5	9	
2 C	8.4.16.1	14	46 /
	9.4.2.2	7	
	9.10.2.4	15	
	9.1.4.6	10	
3 J	5.2.1.4	22	35 /
	9.8.1.1	7	
	9.1.5.3	6	
4 I	7.4.5.1	15	37 /
	9.2.2.4	11	
	9.4.4.4	11	
5 F	8.4.1.1	13	40 /
	9.10.6.3	19	
	9.4.5.3	8	
6 H	8.8.2.1	19	53 /
	9.1.1.5	14	
	9.1.5.4	8	
	9.4.1.3	12	
7 G	1.2.6.3	15	31 /
	9.11.1.6	3	
	9.4.2.4	13	
8 Add.	8.5.8.3	11	8 /
	9.1.3.2	4	
	9.1.2.2	6	
9 E	7.8.3.4	19	66 /
	9.1.3.4	8	
	9.4.2.3	10	
	9.9.2.3	13	
	9.1.2.5	11	
10 Add.	7.2.3.3	6	8 /
	9.1.3.2	4	
11 A	8.8.5.1	21	58 /
	9.9.1.3	15	
	9.10.5.3	13	
	9.4.1.2	9	
12 Add.	7.2.1.4	6	8 /
13 D	7.2.2.1	6	32 /
	9.2.3.4	9	
	9.9.3.3	11	
	9.1.3.3	6	
<b>Total K = 488</b>			

SEQUENCE APPROVED  
 July 5  
  
 16/8/24 16.08

Proposal "A" LTU  
 Pilot  
 A/C



WAC 2024		Form B
Pilot ID	CIVA Unlimited Programme2	
	Flight #	

← wind/vent

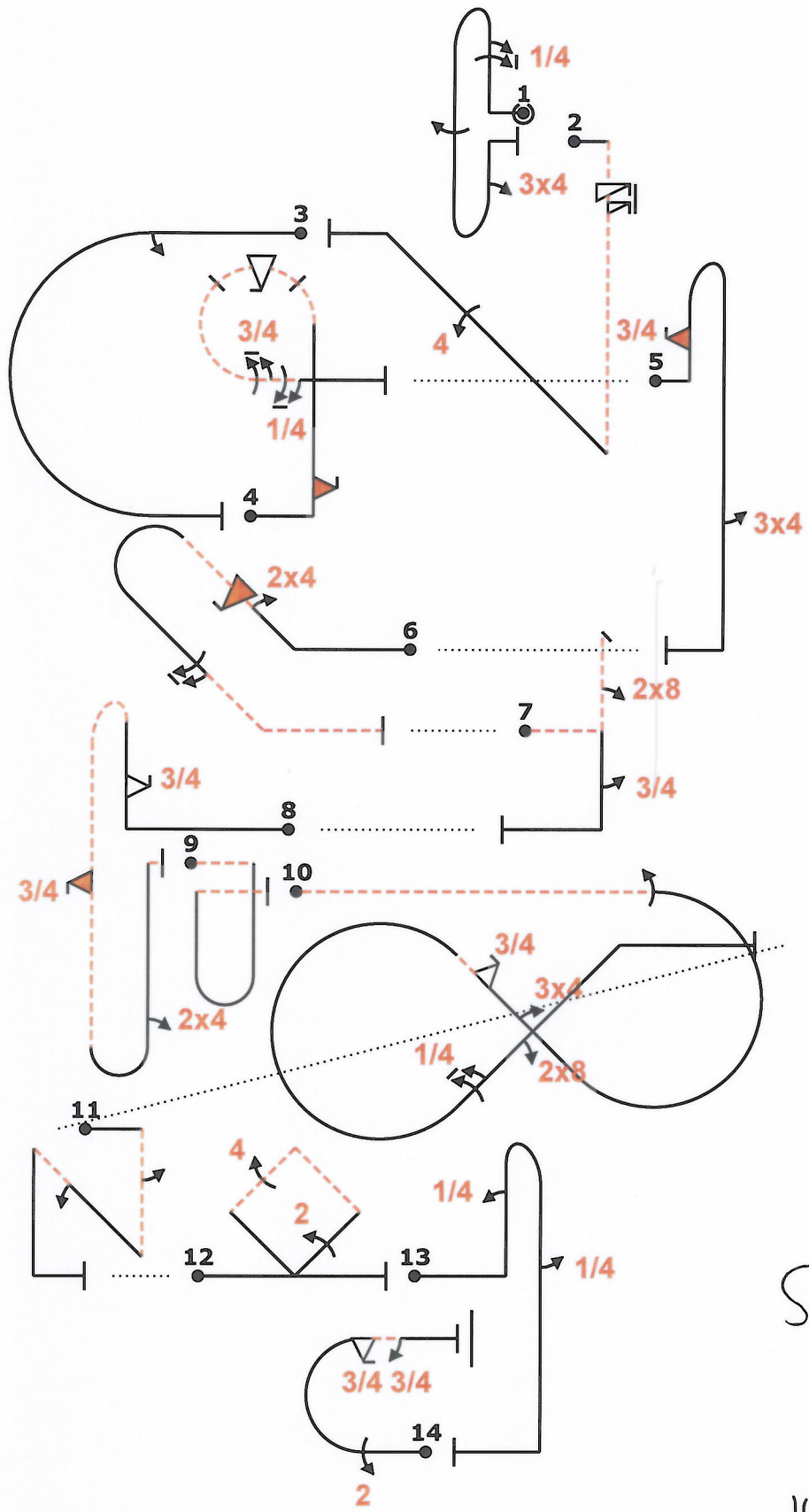

Power			
Fig	Aresti	K	
1 H	8.8.2.1	19	53 ✓
	9.1.1.5	14	
	9.1.5.4	8	
	9.4.1.3	12	
2 G	1.2.6.3	15	31 ✓
	9.11.1.6	3	
	9.4.2.4	13	
3 Add.	7.2.3.3	6	6 ✓
	9.1.3.2	4	
4 B	8.6.4.1	14	66 ✓
	9.10.6.2	19	
	9.9.8.4	13	
	9.1.3.7	11	
	9.1.3.5	9	
5 F	8.4.1.1	13	40 ✓
	9.10.6.3	19	
	9.4.5.3	8	
6 C	8.4.16.1	14	46 ✓
	9.4.2.2	7	
	9.10.2.4	15	
	9.1.4.6	10	
7 J	5.2.1.4	22	35 ✓
	9.8.1.1	7	
	9.1.5.3	6	
8 A	8.8.5.1	21	58 ✓
	9.9.1.3	15	
	9.10.5.3	13	
	9.4.1.2	9	
9 Add.	8.4.1.4	13	6 ✓
10 E	7.8.3.4	19	66 ✓
	9.1.3.4	8	
	9.4.2.3	10	
	9.9.2.3	13	
	9.1.2.5	11	
11 Add.	1.3.16.3	21	6 ✓
	9.1.5.2	4	
	9.1.2.2	6	
12 I	7.4.5.1	15	37 ✓
	9.2.2.4	11	
	9.4.4.4	11	
13 Add.	8.4.1.1	13	6 ✓
	9.1.1.1	6	
	9.1.5.1	2	
14 D	7.2.2.1	6	32 ✓
	9.2.3.4	9	
	9.9.3.3	11	
	9.1.3.3	6	
Total K = 488			

Sequence Approved.

July 8

*[Signature]*

16/8/24  
15.27

Proposal "B" LUX  
Pilot  
A/C





WAC 2024		Form B
Pilot ID	CIVA Unlimited Programme2	
		Flight #

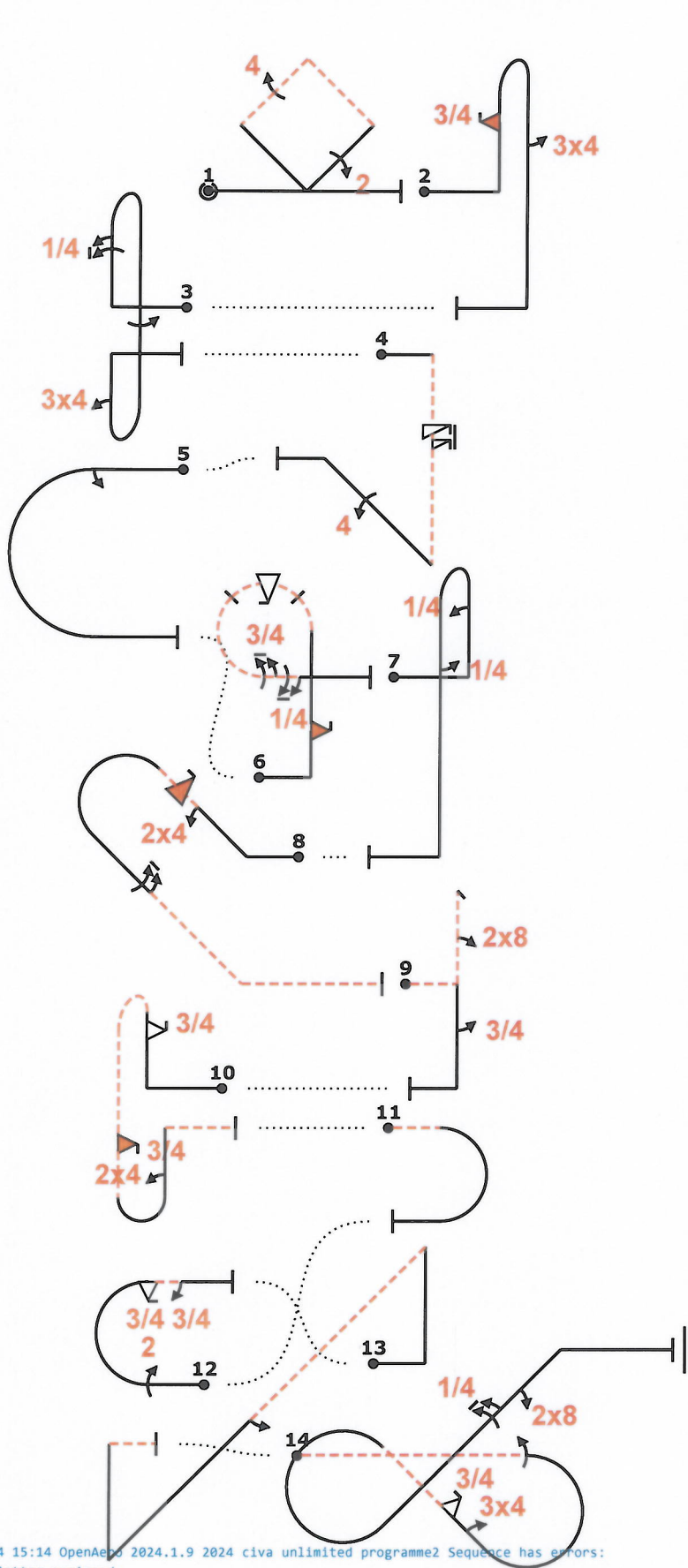

Power			
Fig	Aresti	K	
1 I	7.4.5.1	15	37
	9.2.2.4	11	
	9.4.4.4	11	
2 F	8.4.1.1	13	40
	9.10.6.3	19	
	9.4.5.3	8	
3 H	8.8.2.1	19	53
	9.1.1.5	14	
	9.1.5.4	8	
4 G	9.4.1.3	12	31
	1.2.6.3	15	
	9.11.1.6	3	
5 Add.	9.4.2.4	13	6
	7.2.3.3	6	
	9.1.3.2	4	
6 B	8.6.4.1	14	66
	9.10.6.2	19	
	9.9.8.4	13	
	9.1.3.7	11	
	9.1.3.5	9	
7 Add.	8.4.1.1	13	6
	9.1.1.1	6	
	9.1.5.1	2	
8 C	8.4.16.1	14	46
	9.4.2.2	7	
	9.10.2.4	15	
	9.1.4.6	10	
9 J	5.2.1.4	22	35
	9.8.1.1	7	
	9.1.5.3	6	
10 A	8.8.5.1	21	58
	9.9.1.3	15	
	9.10.5.3	13	
	9.4.1.2	9	
11 Add.	7.2.1.4	6	6
12 D	7.2.2.1	6	32
	9.2.3.4	9	
	9.9.3.3	11	
	9.1.3.3	6	
13 Add.	1.3.11.1	20	6
	9.1.4.2	4	
14	7.8.3.4	19	66
	9.1.3.4	8	
	9.4.2.3	10	
	9.9.2.3	13	
	9.1.2.5	11	
	9.8.2.1	5	
Total K = 488			

Sequence approved

Jury P.

16/8/24

15:30

Check: 16-8-2024 15:14 OpenAero 2024.1.9 2024 civa unlimited programme2 Sequence has errors:  
 (14) No figure letter assigned  
 Unused figure letter(s): E

Proposal "C" HUN  
 Pilot  
 A/C



WAC 2024		Form B
Pilot ID	CIVA Unlimited Programme2	
	Flight #	

← wind/vent

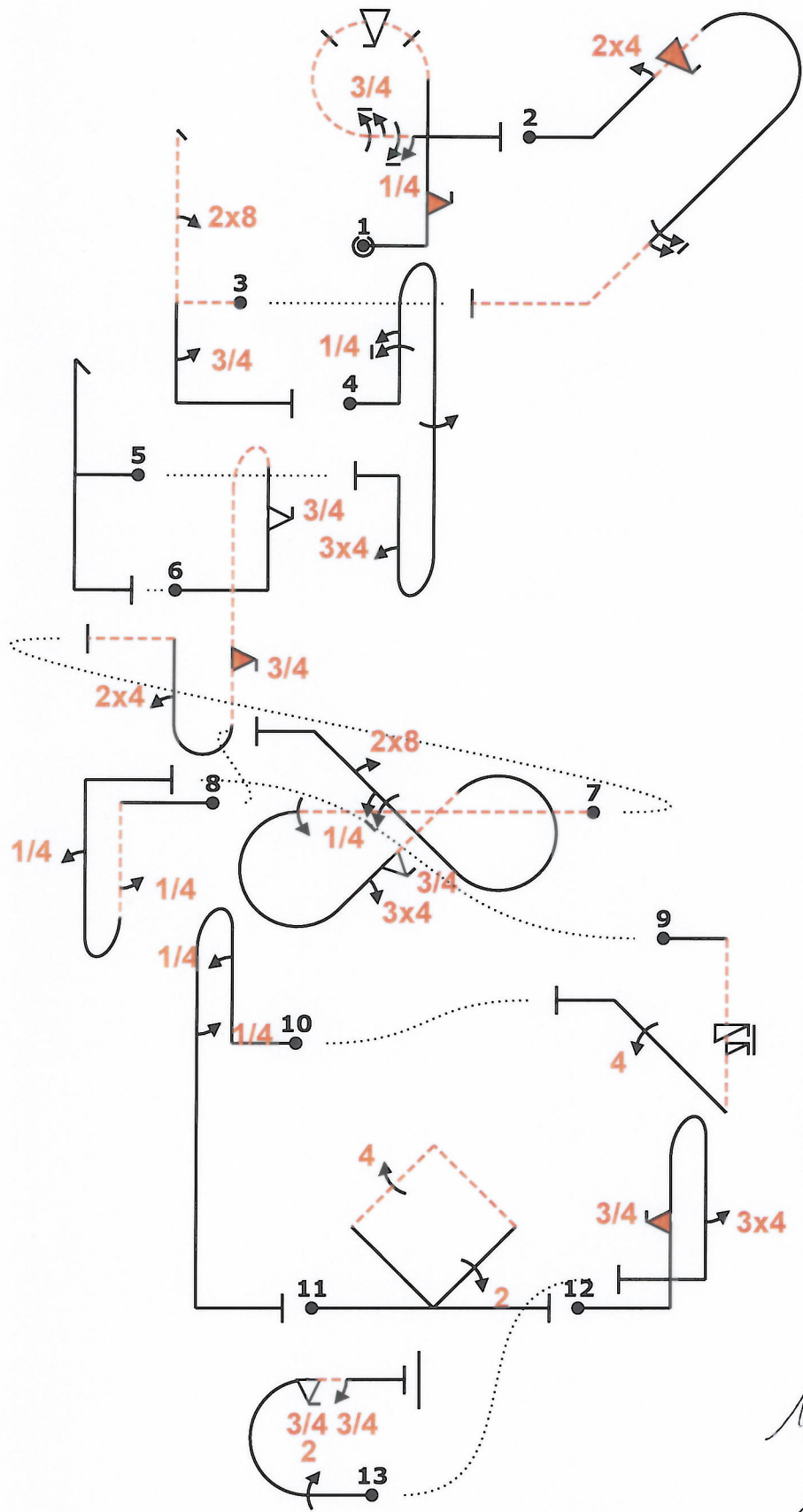

Power			
Fig	Aresti	K	
1 B	8.6.4.1	14	66 ✓
	9.10.6.2	19	
	9.9.8.4	13	
	9.1.3.7	11	
	9.1.3.5	9	
2 C	8.4.16.1	14	46 ✓
	9.4.2.2	7	
	9.10.2.4	15	
	9.1.4.6	10	
3 J	5.2.1.4	22	35 ✓
	9.8.1.1	7	
	9.1.5.3	6	
4 H	8.8.2.1	19	53 ✓
	9.1.1.5	14	
	9.1.5.4	8	
	9.4.1.3	12	
5 Add.	5.2.1.1	17	8 ✓
6 A	8.8.5.1	21	58 ✓
	9.9.1.3	15	
	9.10.5.3	13	
	9.4.1.2	9	
7 E	7.8.3.4	19	66 ✓
	9.1.3.4	8	
	9.4.2.3	10	
	9.9.2.3	13	
	9.1.2.5	11	
8 Add.	8.4.3.3	15	8 ✓
	9.1.5.1	2	
	9.1.1.1	6	
		6	
9 G	1.2.6.3	15	31 ✓
	9.11.1.6	3	
	9.4.2.4	13	
10 Add.	8.4.1.1	13	8 ✓
	9.1.1.1	6	
	9.1.5.1	2	
11 I	7.4.5.1	15	37 ✓
	9.2.2.4	11	
	9.4.4.4	11	
12 F	8.4.1.1	13	40 ✓
	9.10.6.3	19	
	9.4.5.3	8	
13 D	7.2.2.1	6	32 ✓
	9.2.3.4	9	
	9.9.3.3	11	
	9.1.3.3	6	
Total K = 488			

Sawena approved

July 16/8/24

15:33

Proposal "D" SUI Pilot

A/C



WAC 2024		Form B
Pilot ID	CIVA Unlimited Programme2	
	Flight #	

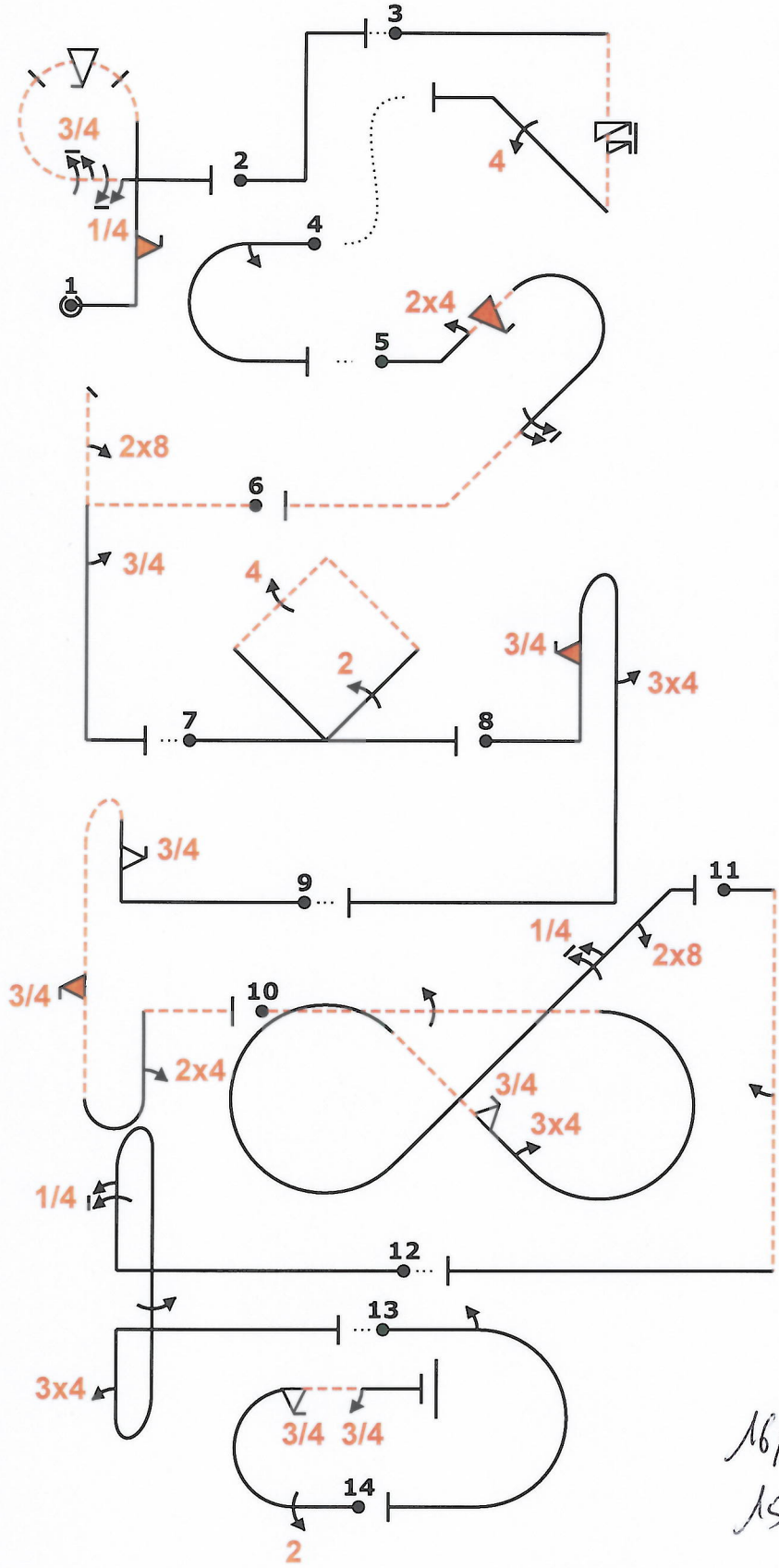
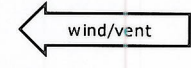

Power			
Fig	Aresti	K	
1 B	8.6.4.1	14	66 ✓
	9.10.6.2	19	
	9.9.8.4	13	
	9.1.3.7	11	
	9.1.3.5	9	
2 Add.	1.1.6.1	10	6 ✓
3 G	1.2.6.3	15	31 ✓
	9.11.1.6	3	
	9.4.2.4	13	
4 Add.	7.2.3.3	6	6 ✓
	9.1.3.2	4	
5 C	8.4.16.1	14	46 ✓
	9.4.2.2	7	
	9.10.2.4	15	
	9.1.4.6	10	
6 J	5.2.1.4	22	35 ✓
	9.8.1.1	7	
	9.1.5.3	6	
7 I	7.4.5.1	15	37 ✓
	9.2.2.4	11	
	9.4.4.4	11	
8 F	8.4.1.1	13	40 ✓
	9.10.6.3	19	
	9.4.5.3	8	
9 A	8.8.5.1	21	58 ✓
	9.9.1.3	15	
	9.10.5.3	13	
	9.4.1.2	9	
10 E	7.8.3.4	19	66 ✓
	9.1.3.4	8	
	9.4.2.3	10	
	9.9.2.3	13	
	9.1.2.5	11	
	9.8.2.1	5	
11 Add.	1.1.6.3	10	6 ✓
	9.1.5.2	4	
12 H	8.8.2.1	19	53 ✓
	9.1.1.5	14	
	9.1.5.4	8	
	9.4.1.3	12	
13 Add.	7.2.3.3	6	6 ✓
	9.1.3.2	4	
14 D	7.2.2.1	6	32 ✓
	9.2.3.4	9	
	9.9.3.3	11	
	9.1.3.3	6	
Total K = 488			

Sequence approved

16/8/24  
15:28

[Signature]

Proposal "E" H/C Pilot

A/C





WAC 2024		Form B
Pilot ID	CIVA Unlimited Programme2	
	Flight #	

← wind/vent

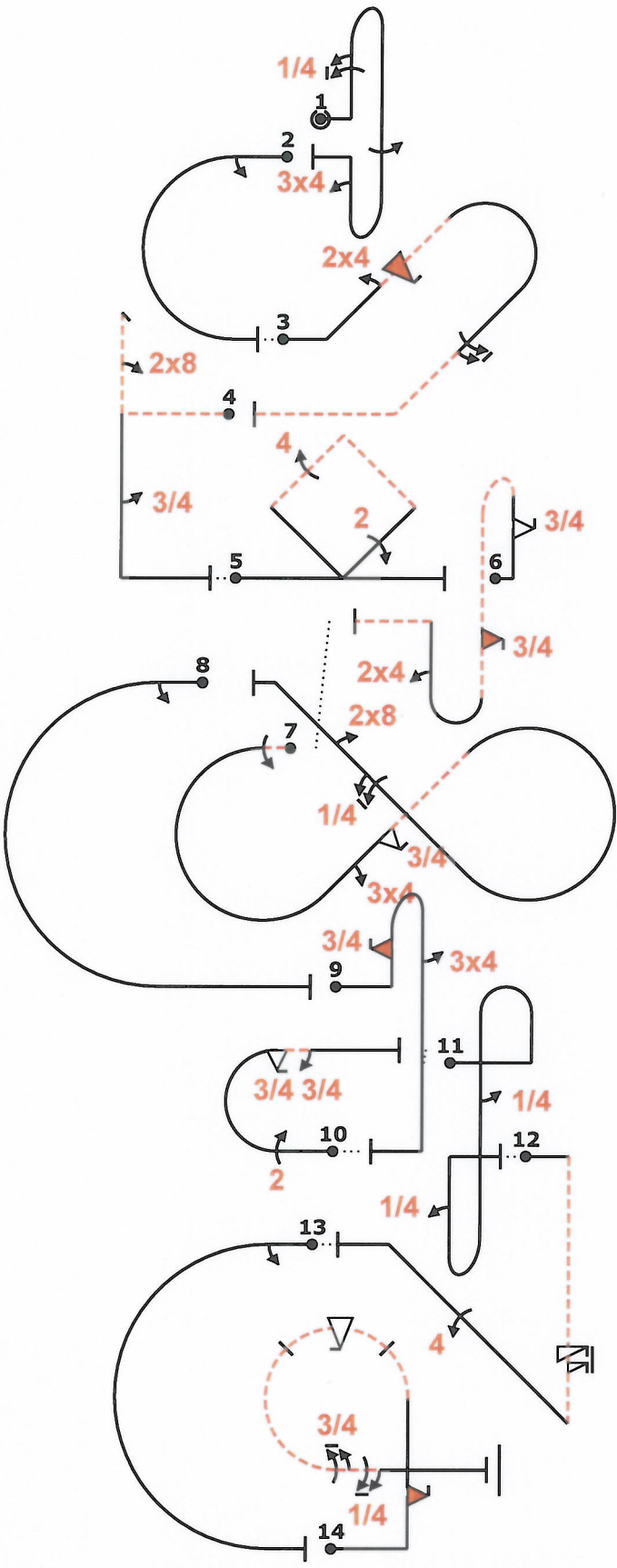

Power			
Fig	Aresti	K	
1 H	8.8.2.1	19	53
	9.1.1.5	14	
	9.1.5.4	8	
	9.4.1.3	12	
2 Add.	7.2.3.3	6	6
	9.1.3.2	4	
3 C	8.4.16.1	14	46
	9.4.2.2	7	
	9.10.2.4	15	
	9.1.4.6	10	
4 J	5.2.1.4	22	35
	9.8.1.1	7	
	9.1.5.3	6	
5 I	7.4.5.1	15	37
	9.2.2.4	11	
	9.4.4.4	11	
6 A	8.8.5.1	21	58
	9.9.1.3	15	
	9.10.5.3	13	
	9.4.1.2	9	
7 E	7.8.3.4	19	66
	9.1.3.4	8	
	9.4.2.3	10	
	9.9.2.3	13	
	9.1.2.5	11	
9.8.2.1	5		
8 Add.	7.2.3.3	6	6
	9.1.3.2	4	
9 F	8.4.1.1	13	40
	9.10.6.3	19	
	9.4.5.3	8	
10 D	7.2.2.1	6	32
	9.2.3.4	9	
	9.9.3.3	11	
	9.1.3.3	6	
11 Add.	8.8.2.1	19	6
	9.1.5.1	2	
	9.1.1.1	6	
12 G	1.2.6.3	15	31
	9.11.1.6	3	
	9.4.2.4	13	
13 Add.	7.2.3.3	6	6
	9.1.3.2	4	
14 B	8.6.4.1	14	66
	9.10.6.2	19	
	9.9.8.4	13	
	9.1.3.7	11	
	9.1.3.5	9	
<b>Total K = 488</b>			

SEQUENCE APPROVED.

Jan 2

16/8/24

15.36

Proposal "F" CZE  
Pilot  
A/C



WAC 2024		Form B
Pilot ID	CIVA Unlimited Unknown1	
		Flight #

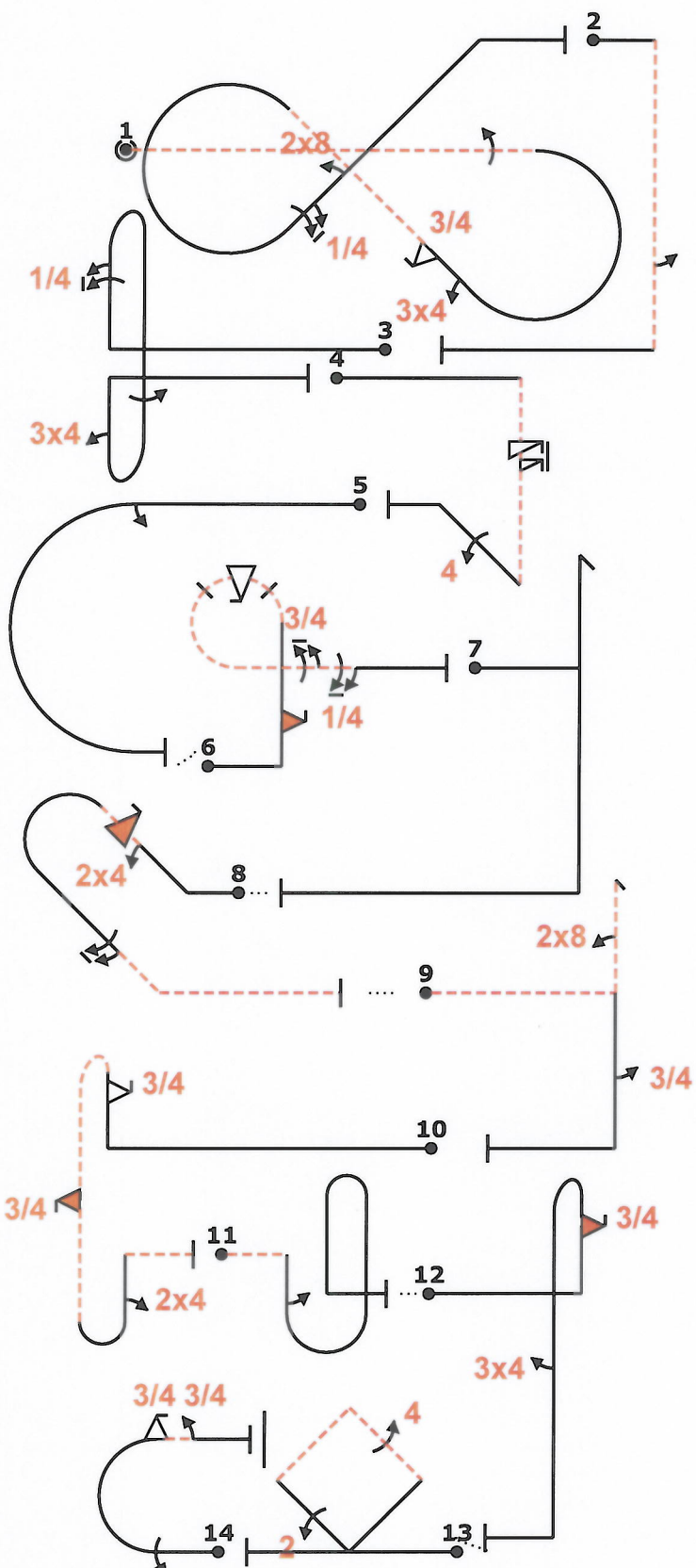

Power		
Fig	Aresti	K
1	7.8.3.4	19
	9.1.3.4	8
	9.4.2.3	10
	9.9.2.3	13
	9.1.2.5	11
	9.8.2.1	5
66		
2	1.1.6.3	10
	9.1.5.2	4
6		
3	8.8.2.1	19
	9.1.1.5	14
	9.1.5.4	8
	9.4.1.3	12
53		
4	1.2.6.3	15
	9.1.1.6	3
	9.4.2.4	13
31		
5	7.2.3.3	6
	9.1.3.2	4
6		
6	8.6.4.1	14
	9.10.6.2	19
	9.9.8.4	13
	9.1.3.7	11
	9.1.3.5	9
66		
7	5.2.1.1	17
6		
8	8.4.16.1	14
	9.4.2.2	7
	9.10.2.4	15
	9.1.4.6	10
46		
9	5.2.1.4	22
	9.8.1.1	7
	9.1.5.3	6
35		
10	8.8.5.1	21
	9.9.1.3	15
	9.10.5.3	13
	9.4.1.2	9
58		
11	8.8.1.4	18
	9.1.5.2	4
6		
12	8.4.1.1	13
	9.10.6.3	19
	9.4.5.3	8
40		
13	7.4.5.1	15
	9.2.2.4	11
	9.4.4.4	11
37		
14	7.2.2.1	6
	9.2.3.4	9
	9.9.3.3	11
	9.1.3.3	6
32		
<b>Total K = 488</b>		

SEQUENCE APPROVED  
 JULY 8.  
  
 16/8/24  
 16-20

Check: 16-8-2024 16:18 OpenAero 2024.1.9 2024 civa unlimited unknown1 Sequence has errors:  
 (1) No figure letter assigned  
 Unused figure letter(s): E

Proposal "G" ESP Pilot  
 A/C





WAC 2024		Form B
Pilot ID	CIVA Unlimited Programme2	
		Flight #

← wind/vent

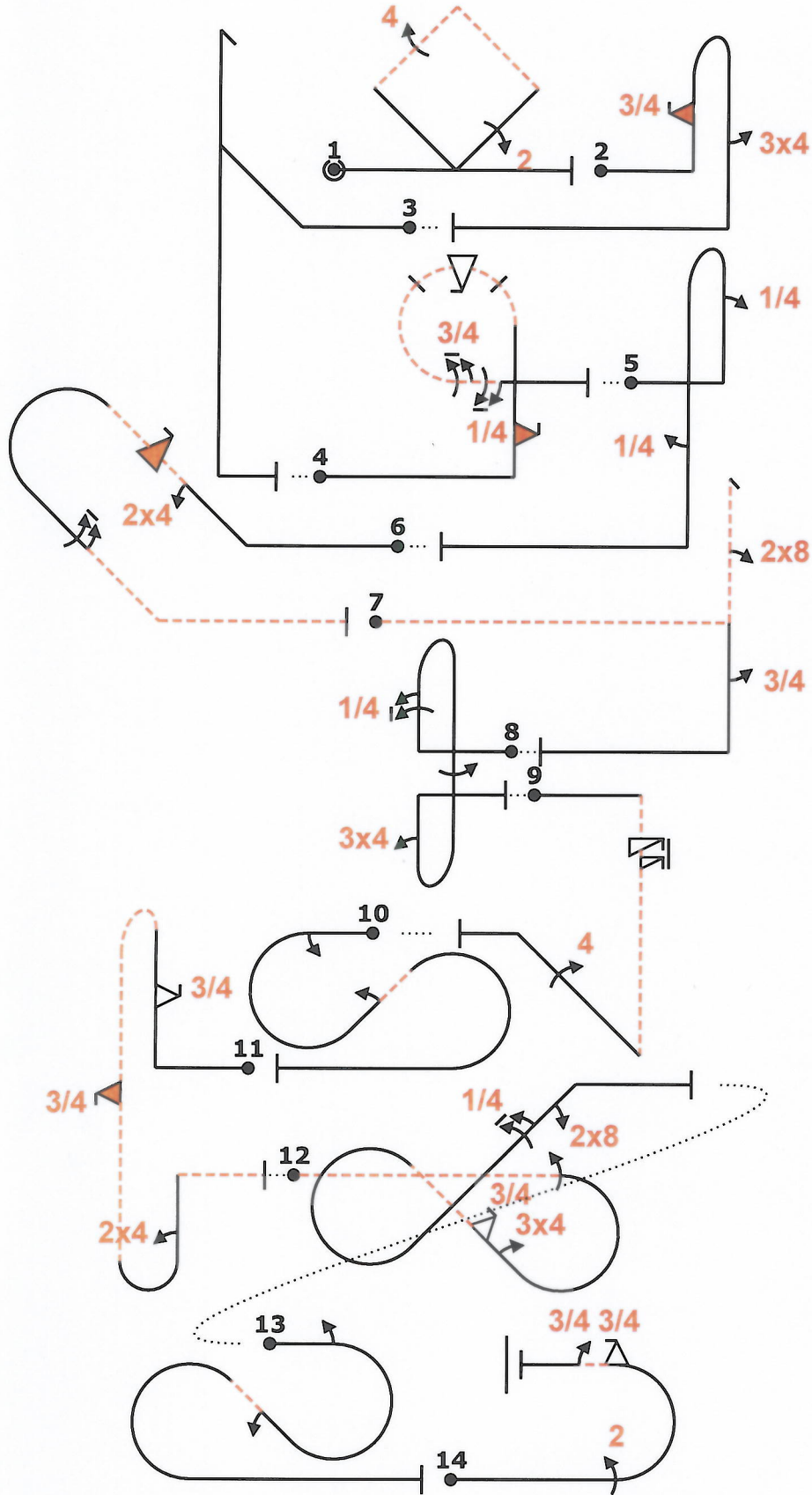

Power		
Fig	Aresti	K
1 I	7.4.5.1	15
	9.2.2.4	11
	9.4.4.4	11
2 F	8.4.1.1	13
	9.10.6.3	19
	9.4.5.3	8
3 Add.	5.3.1.1	18
4 B	8.6.4.1	14
	9.10.6.2	19
	9.9.8.4	13
	9.1.3.7	11
	9.1.3.5	9
5 Add.	8.4.1.1	13
	9.1.1.1	6
	9.1.5.1	2
6 C	8.4.16.1	14
	9.4.2.2	7
	9.10.2.4	15
	9.1.4.6	10
7 J	5.2.1.4	22
	9.8.1.1	7
	9.1.5.3	6
8 H	8.8.2.1	19
	9.1.1.5	14
	9.1.5.4	8
	9.4.1.3	12
9 G	1.2.6.3	15
	9.11.1.6	3
	9.4.2.4	13
10 Add.	7.5.5.3	15
	9.1.3.2	4
	9.1.2.2	6
11 A	8.8.5.1	21
	9.9.1.3	15
	9.10.5.3	13
	9.4.1.2	9
12 E	7.8.3.4	19
	9.1.3.4	8
	9.4.2.3	10
	9.9.2.3	13
	9.1.2.5	11
9.8.2.1	5	
13 Add.	7.5.5.3	15
	9.1.3.2	4
	9.1.2.2	6
14 D	7.2.2.1	6
	9.2.3.4	9
	9.9.3.3	11
	9.1.3.3	6
<b>Total K = 488</b>		

SEQUENCE APPROVED

JULY 9

*[Signature]*

16/8/24

15.40

Proposal "H" USA  
 Pilot  
 A/C





WAC 2024		Form B
Pilot ID	CIVA Unlimited Programme2	Flight #

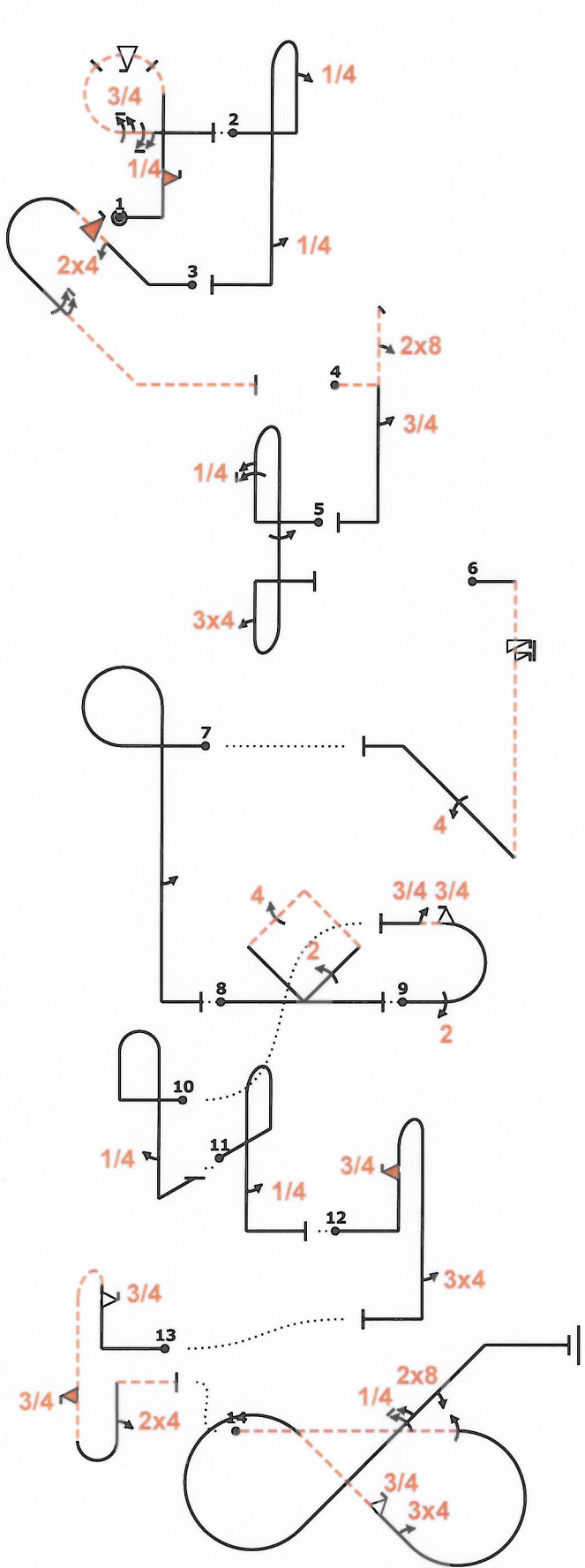

Power			
Fig	Aresti	K	
1 B	8.6.4.1	14	66 ✓
	9.10.6.2	19	
	9.9.8.4	13	
	9.1.3.7	11	
	9.1.3.5	9	
2 Add.	8.4.1.1	13	6 ✓
	9.1.1.1	6	
	9.1.5.1	2	
3 C	8.4.16.1	14	46 ✓
	9.4.2.2	7	
	9.10.2.4	15	
	9.1.4.6	10	
4 J	5.2.1.4	22	35 ✓
	9.8.1.1	7	
	9.1.5.3	6	
5 H	8.8.2.1	19	53 ✓
	9.1.1.5	14	
	9.1.5.4	8	
	9.4.1.3	12	
6 G	1.2.6.3	15	31 ✓
	9.11.1.6	3	
	9.4.2.4	13	
7 Add.	8.6.5.1	11	6 ✓
	9.1.5.2	4	
8 I	7.4.5.1	15	37 ✓
	9.2.2.4	11	
	9.4.4.4	11	
9 D	7.2.2.1	6	32 ✓
	9.2.3.4	9	
	9.9.3.3	11	
	9.1.3.3	6	
10 Add.	8.4.1.1	13	6 ✓
	9.1.5.1	2	
11 Add.	8.4.1.1	13	6 ✓
	9.1.5.1	2	
12 F	8.4.1.1	13	40 ✓
	9.10.6.3	19	
	9.4.5.3	8	
13 A	8.8.5.1	21	58 ✓
	9.9.1.3	15	
	9.10.5.3	13	
	9.4.1.2	9	
14 E	7.8.3.4	19	66 ✓
	9.1.3.4	8	
	9.4.2.3	10	
	9.9.2.3	13	
	9.1.2.5	11	
	9.8.2.1	5	
<b>Total K = 488</b>			

SEQUENCE APPROVED.

July 5

16/8/24 15.45

Proposal "I" CZE  
 Pilot  
 A/C



WAC 2024		Form B
Pilot ID	CIVA Unlimited Unknown1	
		Flight #

← wind/vent

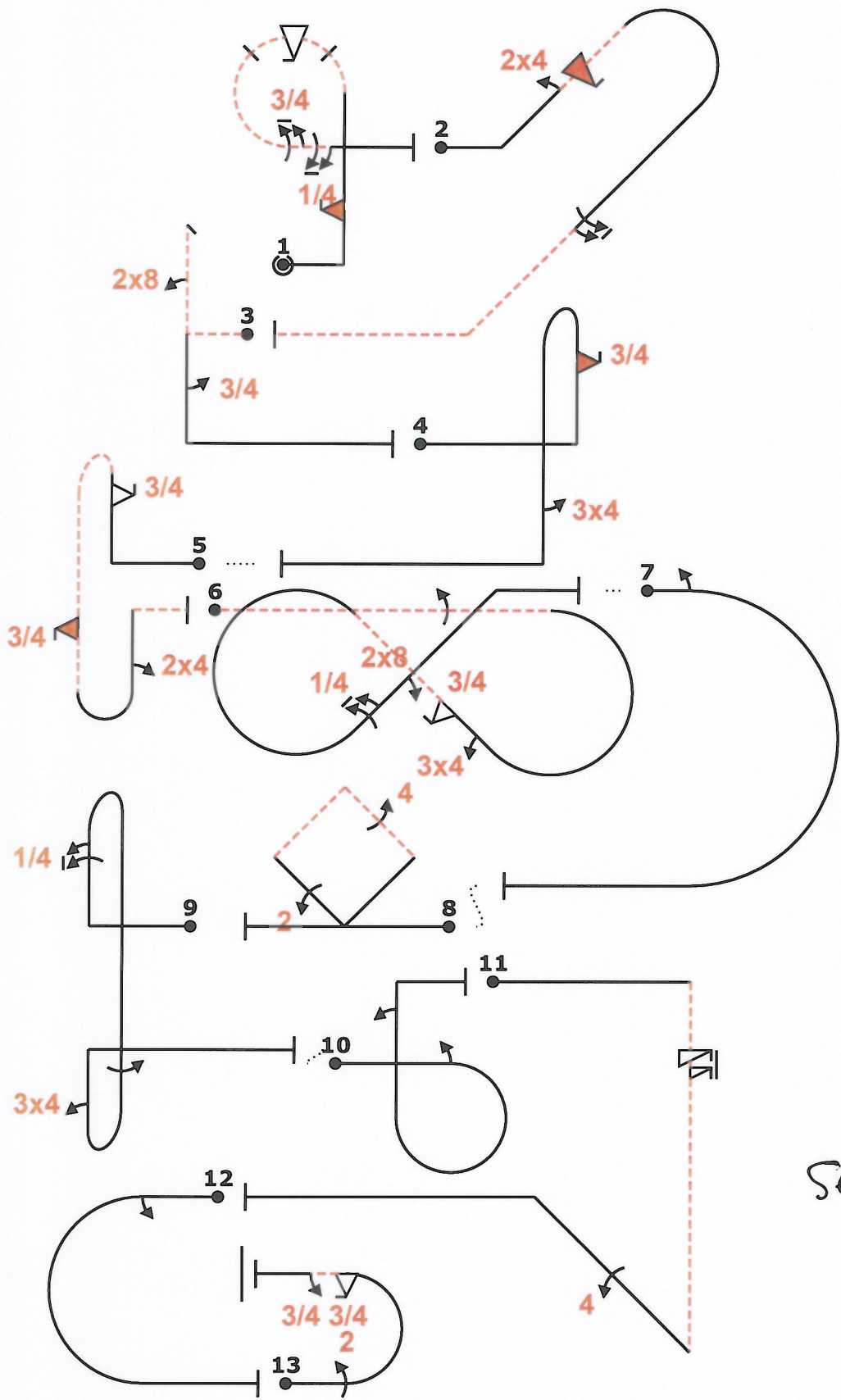

Power			
Fig	Aresti	K	
1 B	8.6.4.1	14	66
	9.10.6.2	19	
	9.9.8.4	13	
	9.1.3.7	11	
	9.1.3.5	9	
2 C	8.4.16.1	14	46
	9.4.2.2	7	
	9.10.2.4	15	
	9.1.4.6	10	
3 J	5.2.1.4	22	35
	9.8.1.1	7	
	9.1.5.3	6	
4 F	8.4.1.1	13	40
	9.10.6.3	19	
	9.4.5.3	8	
5 A	8.8.5.1	21	58
	9.9.1.3	15	
	9.10.5.3	13	
	9.4.1.2	9	
6 E	7.8.3.4	19	66
	9.1.3.4	8	
	9.4.2.3	10	
	9.9.2.3	13	
	9.1.2.5	11	
7 Add.	9.8.2.1	5	8
	7.2.3.3	6	
	9.1.3.2	4	
8 I	7.4.5.1	15	37
	9.2.2.4	11	
	9.4.4.4	11	
9 H	8.8.2.1	19	53
	9.1.1.5	14	
	9.1.5.4	8	
	9.4.1.3	12	
10 Add.	8.6.8.3	12	8
	9.1.3.2	4	
	9.1.1.2	8	
11 G	1.2.6.3	15	31
	9.11.1.6	3	
	9.4.2.4	13	
12 Add.	7.2.3.3	6	8
	9.1.3.2	4	
13 D	7.2.2.1	6	32
	9.2.3.4	9	
	9.9.3.3	11	
	9.1.3.3	6	
Total K = 488			

SEQUENCE APPROVED

JUNE

[Signature]

16/8/24

16-15

Proposal "J" ESP  
Pilot  
A/C





WAC 2024		Form B
Pilot ID	CIVA Unlimited Programme2	
		Flight #

← wind/vent

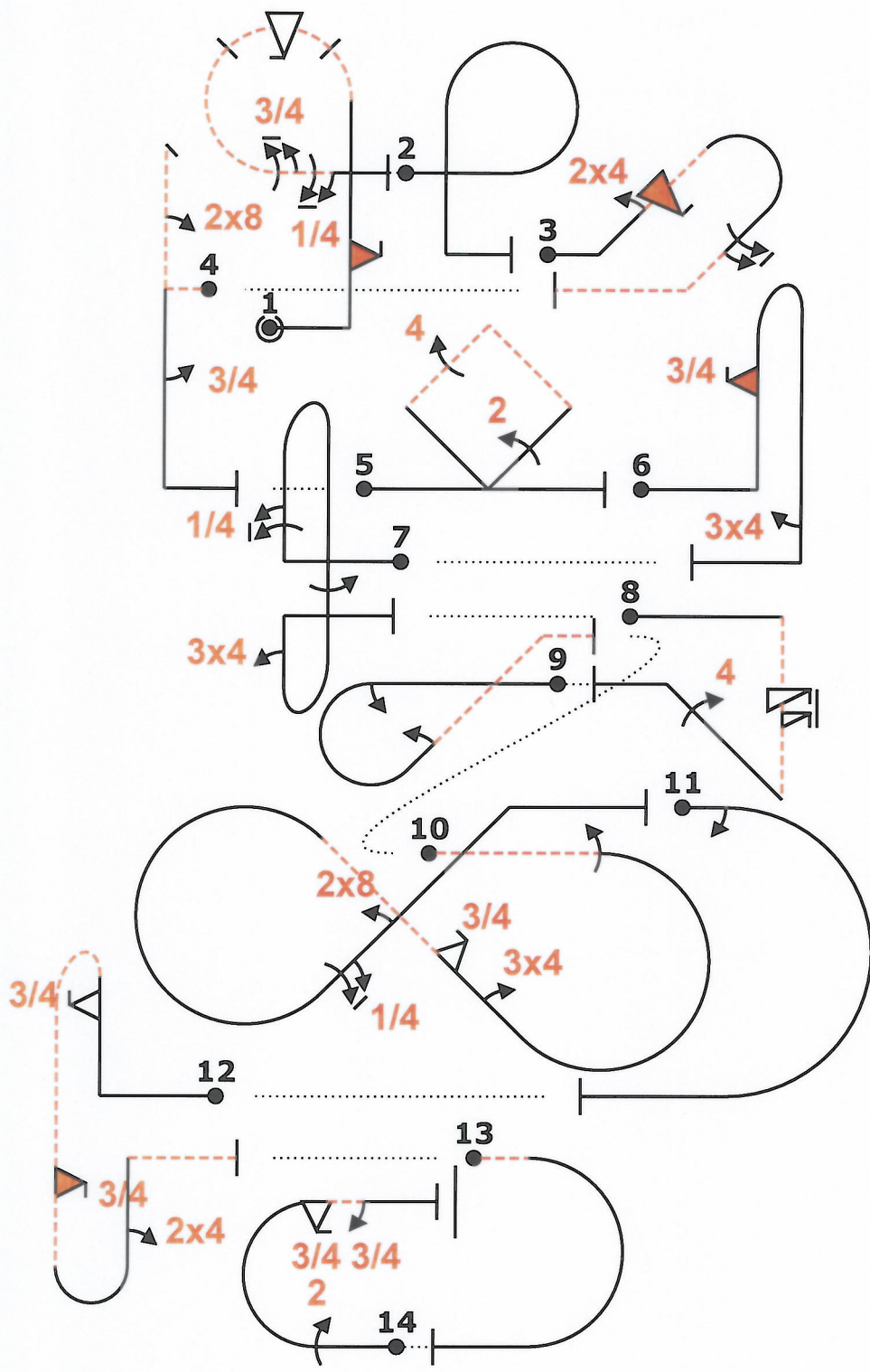

Power			
Fig	Aresti	K	
1 B	8.6.4.1	14	66 /
	9.10.6.2	19	
	9.9.8.4	13	
	9.1.3.7	11	
	9.1.3.5	9	
2 Add.	8.6.5.1	11	6 /
3 C	8.4.16.1	14	46 /
	9.4.2.2	7	
	9.10.2.4	15	
	9.1.4.6	10	
4 J	5.2.1.4	22	35 /
	9.8.1.1	7	
	9.1.5.3	6	
5 I	7.4.5.1	15	37 /
	9.2.2.4	11	
	9.4.4.4	11	
6 F	8.4.1.1	13	40 /
	9.10.6.3	19	
	9.4.5.3	8	
7 H	8.8.2.1	19	53 /
	9.1.1.5	14	
	9.1.5.4	8	
	9.4.1.3	12	
8 G	1.2.6.3	15	31 /
	9.11.1.6	3	
	9.4.2.4	13	
9 Add.	8.5.8.3	11	6 /
	9.1.3.2	4	
	9.1.2.2	6	
10 E	7.8.3.4	19	66 /
	9.1.3.4	8	
	9.4.2.3	10	
	9.9.2.3	13	
	9.1.2.5	11	
	9.8.2.1	5	
11 Add.	7.2.3.3	6	6 /
	9.1.3.2	4	
12 A	8.8.5.1	21	58 /
	9.9.1.3	15	
	9.10.5.3	13	
	9.4.1.2	9	
13 Add.	7.2.1.4	6	6 /
14 D	7.2.2.1	6	32 /
	9.2.3.4	9	
	9.9.3.3	11	
	9.1.3.3	6	
Total K = 488			

SEQUENCE APPROVED  
 July 8  
 16/8/24 16.03

Proposal "K" LTU Pilot  
 A/C



WAC 2024		Form B
Pilot ID	CIVA Unlimited Programme2	Flight #

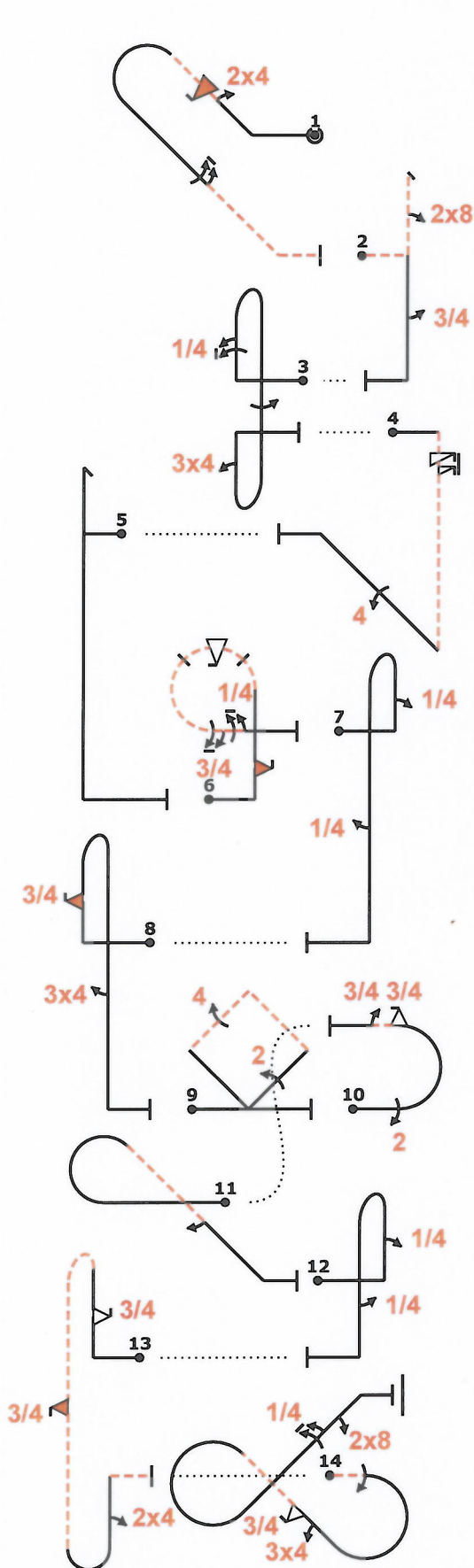

← wind/vent

Power		
Fig	Aresti	K
1 C	8.4.16.1	14
	9.4.2.2	7
	9.10.2.4	15
2 J	5.2.1.4	22
	9.8.1.1	7
	9.1.5.3	6
3 H	8.8.2.1	19
	9.1.1.5	14
	9.1.5.4	8
4 G	1.2.6.3	15
	9.11.1.6	3
	9.4.2.4	13
5 Add.	5.2.1.1	17
6 B	8.6.4.1	14
	9.10.6.2	19
	9.9.8.4	13
	9.1.3.7	11
	9.1.3.5	9
7 Add.	8.4.1.1	13
	9.1.1.1	6
	9.1.5.1	2
8 F	8.4.1.1	13
	9.10.6.3	19
	9.4.5.3	8
9 I	7.4.5.1	15
	9.2.2.4	11
	9.4.4.4	11
10 D	7.2.2.1	6
	9.2.3.4	9
	9.9.3.3	11
	9.1.3.3	6
11 Add.	8.5.6.1	10
	9.1.4.2	4
12 Add.	8.4.1.1	13
	9.1.1.1	6
	9.1.5.1	2
13 A	8.8.5.1	21
	9.9.1.3	15
	9.10.5.3	13
	9.4.1.2	9
14 E	7.8.3.4	19
	9.1.3.4	8
	9.4.2.3	10
	9.9.2.3	13
	9.1.2.5	11
9.8.2.1	5	
<b>Total K = 488</b>		

*Sequence approved  
Jury P.  
16/8/24  
15:36*

Proposal "L" FRA Pilot  
A/C





WAC 2024		Form B
Pilot ID	CIVA Unlimited Programme2	
		Flight #

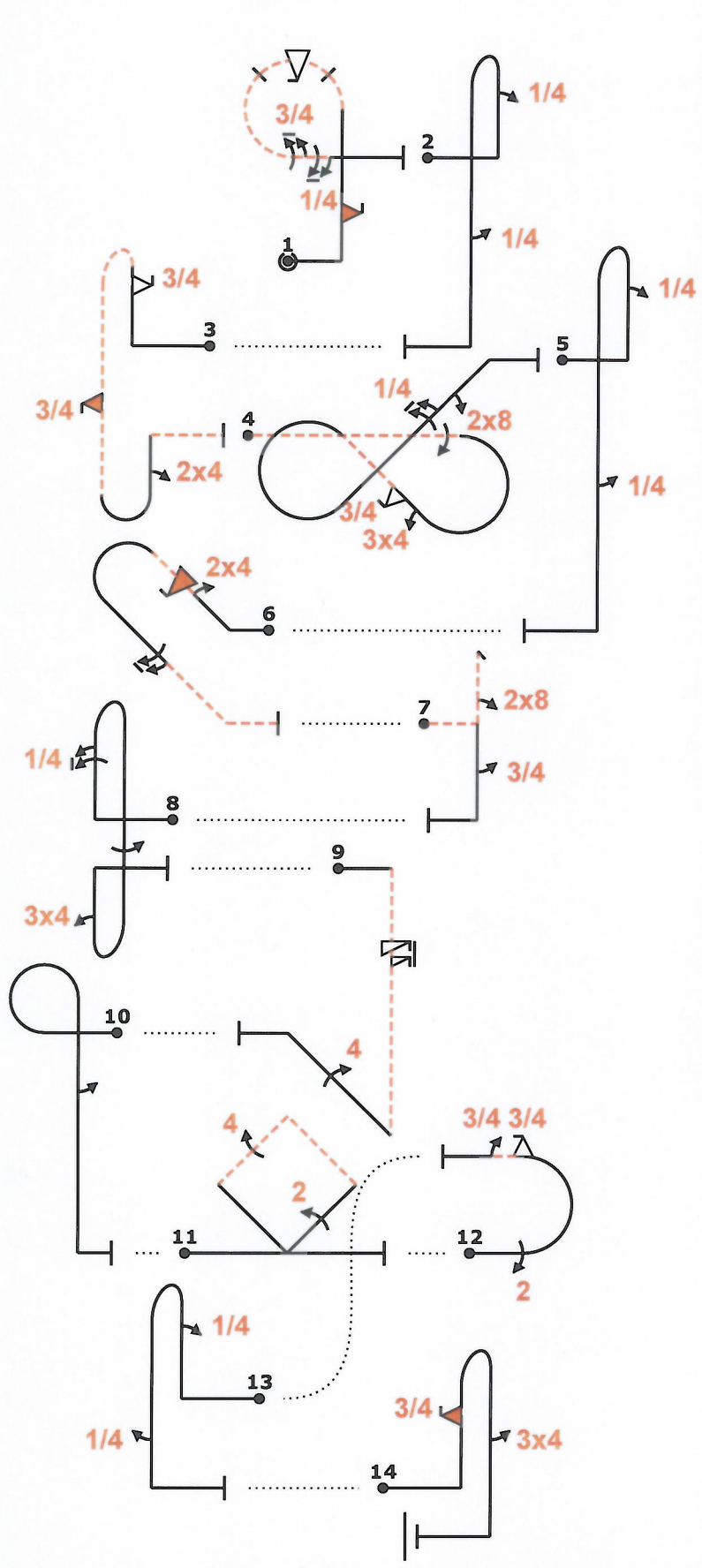

Power		
Fig	Aresti	K
1 B	8.6.4.1	14
	9.10.6.2	19
	9.9.8.4	13
	9.1.3.7	11
	9.1.3.5	9
2 Add.	8.4.1.1	13
	9.1.1.1	6
	9.1.5.1	2
3 A	8.8.5.1	21
	9.9.1.3	15
	9.10.5.3	13
	9.4.1.2	9
4 E	7.8.3.4	19
	9.1.3.4	8
	9.4.2.3	10
	9.9.2.3	13
	9.1.2.5	11
	9.8.2.1	5
5 Add.	8.4.1.1	13
	9.1.1.1	6
	9.1.5.1	2
6 C	8.4.16.1	14
	9.4.2.2	7
	9.10.2.4	15
	9.1.4.6	10
7 J	5.2.1.4	22
	9.8.1.1	7
	9.1.5.3	6
8 H	8.8.2.1	19
	9.1.1.5	14
	9.1.5.4	8
	9.4.1.3	12
9 G	1.2.6.3	15
	9.11.1.6	3
	9.4.2.4	13
10 Add.	8.6.5.1	11
	9.1.5.2	4
11 I	7.4.5.1	15
	9.2.2.4	11
	9.4.4.4	11
12 D	7.2.2.1	6
	9.2.3.4	9
	9.9.3.3	11
	9.1.3.3	6
13 Add.	8.4.1.1	13
	9.1.1.1	6
	9.1.5.1	2
14 F	8.4.1.1	13
	9.10.6.3	19
	9.4.5.3	8
<b>Total K = 488</b>		

Sequence approved.  
 Jörg P.  
 16/8/24  
 15:37

Proposal "M" FRA Pilot  
 A/C



WAC 2024		Form B
Pilot ID	CIVA Unlimited Programme2	
		Flight #

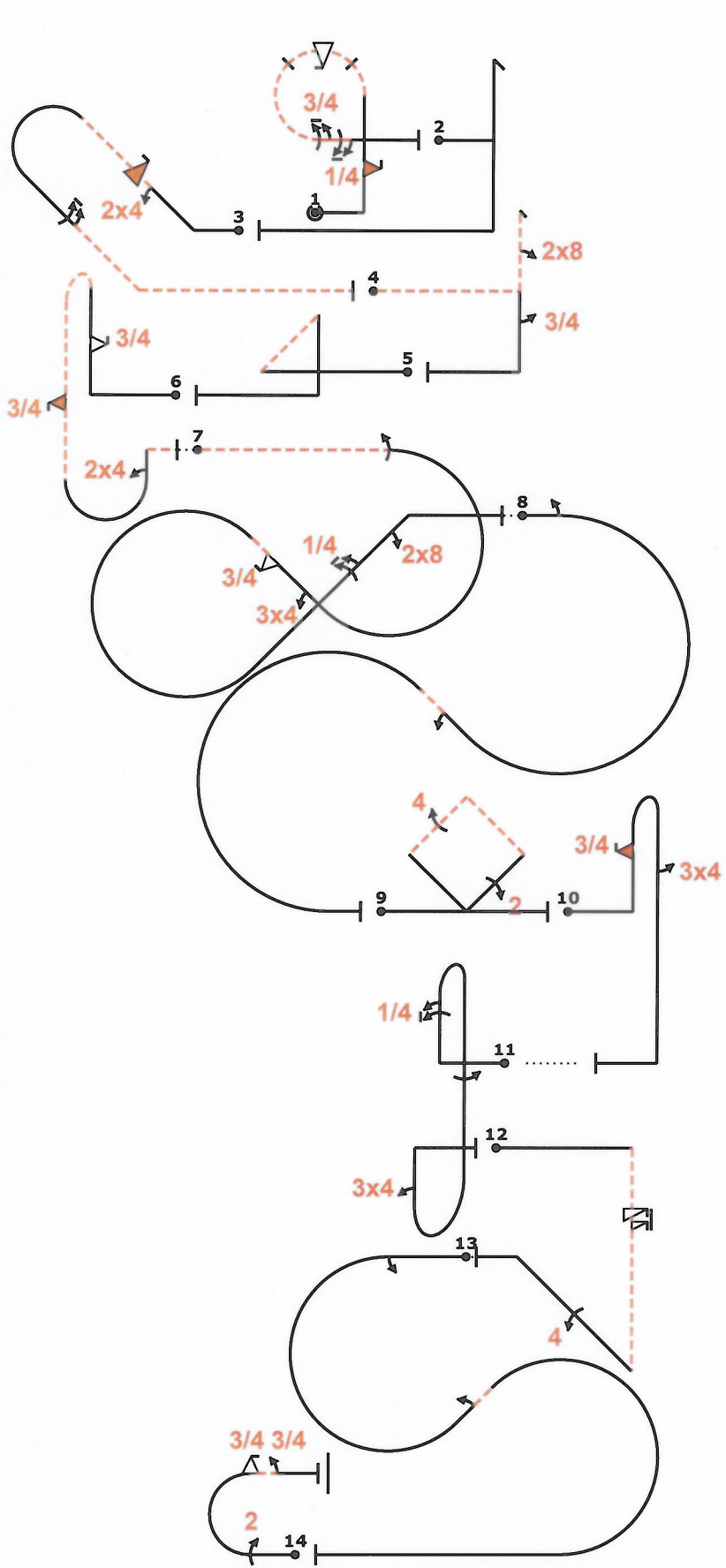

← wind/vent

Power			
Fig	Aresti	K	
1 B	8.6.4.1	14	66 ✓
	9.10.6.2	19	
	9.9.8.4	13	
	9.1.3.7	11	
	9.1.3.5	9	
2	5.2.1.1	17	6 ✓
3 C	8.4.16.1	14	46 ✓
	9.4.2.2	7	
	9.10.2.4	15	
	9.1.4.6	10	
4 J	5.2.1.4	22	35 ✓
	9.8.1.1	7	
	9.1.5.3	6	
5	1.2.9.1	15	6 ✓
6 A	8.8.5.1	21	58 ✓
	9.9.1.3	15	
	9.10.5.3	13	
	9.4.1.2	9	
7 E	7.8.3.4	19	66 ✓
	9.1.3.4	8	
	9.4.2.3	10	
	9.9.2.3	13	
	9.1.2.5	11	
8	9.8.2.1	5	
8 Add.	7.5.5.3	15	6 ✓
	9.1.3.2	4	
	9.1.2.2	6	
9 I	7.4.5.1	15	37 ✓
	9.2.2.4	11	
	9.4.4.4	11	
10 F	8.4.1.1	13	40 ✓
	9.10.6.3	19	
	9.4.5.3	8	
11 H	8.8.2.1	19	53 ✓
	9.1.1.5	14	
	9.1.5.4	8	
	9.4.1.3	12	
12 G	1.2.6.3	15	31 ✓
	9.11.1.6	3	
	9.4.2.4	13	
13 Add.	7.5.5.3	15	6 ✓
	9.1.3.2	4	
	9.1.2.2	6	
14 D	7.2.2.1	6	32 ✓
	9.2.3.4	9	
	9.9.3.3	11	
	9.1.3.3	6	
Total K = 488			

Sequence approved  
 Jerry P.  
 16/8/24  
 15:38.

Proposal "N" ROU  
 Pilot  
 A/C





WAC 2024		Form B
Pilot ID	CIVA Unlimited Programme2	
		Flight #

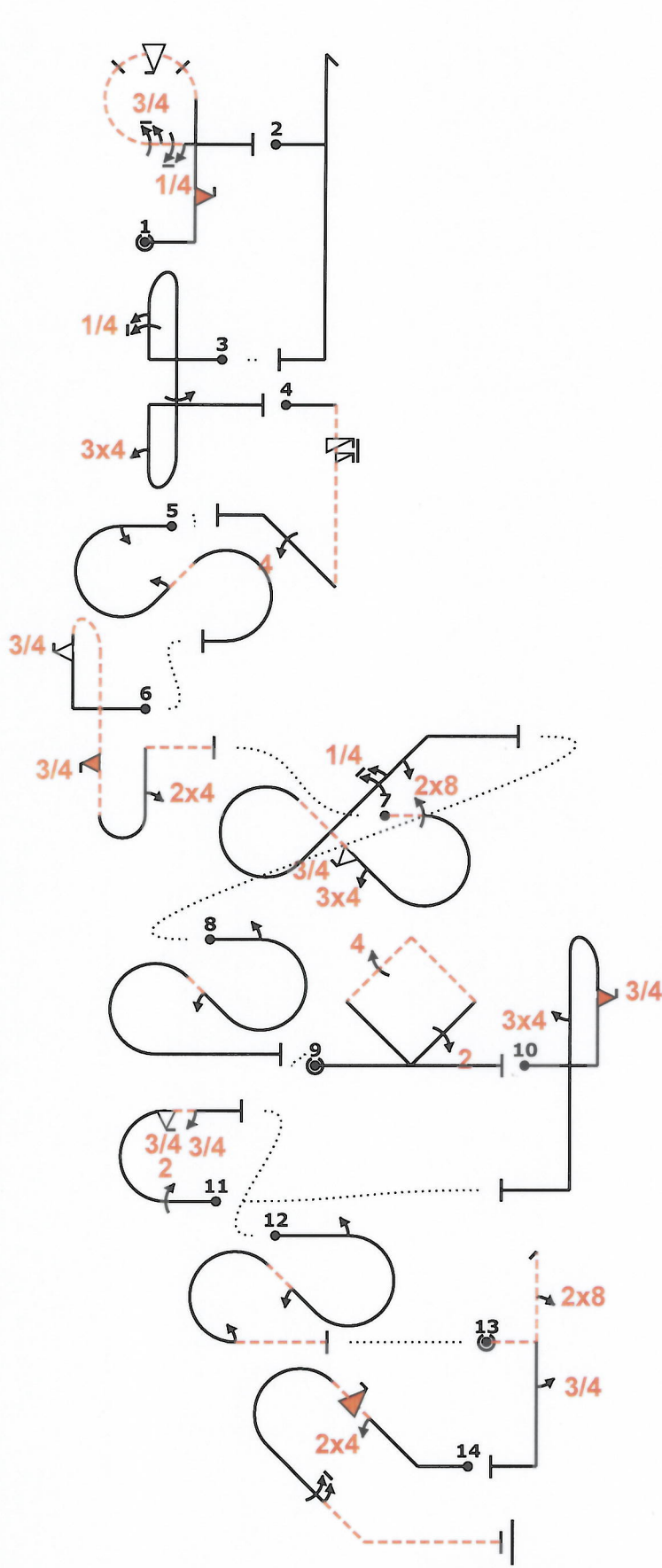









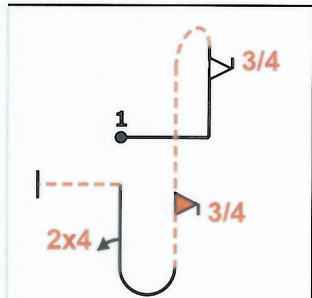

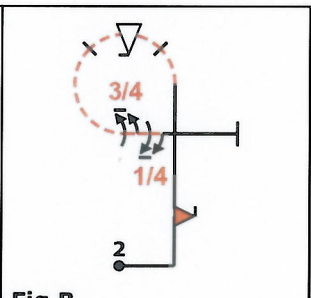

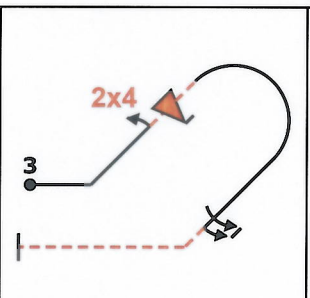

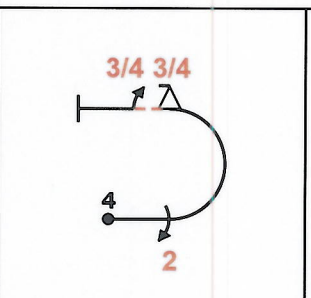

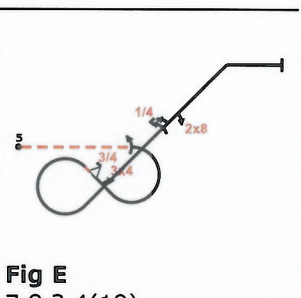

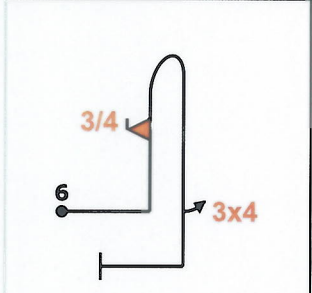
Power			
Fig	Aresti	K	
1	8.6.4.1	14	
	9.10.6.2	19	
	9.9.8.4	13	
	9.1.3.7	11	
	9.1.3.5	9	
66		/	
2	5.2.1.1		17
	6		
3	8.8.2.1		19
	9.1.1.5		14
	9.1.5.4	8	
	9.4.1.3	12	
53		/	
4	1.2.6.3		15
	9.11.1.6		3
	9.4.2.4		13
31		/	
5	7.5.5.3		15
	9.1.3.2		4
	9.1.2.2	6	
6		/	
6	8.8.5.1		21
	9.9.1.3		15
	9.10.5.3		13
	9.4.1.2		9
58		/	
7	7.8.3.4		19
	9.1.3.4		8
	9.4.2.3		10
	9.9.2.3		13
	9.1.2.5	11	
66		/	
8	7.5.5.3		15
	9.1.3.2		4
	9.1.2.2		6
6			/
9	7.4.5.1	15	
	9.2.2.4	11	
	9.4.4.4	11	
37		/	
10	8.4.1.1		13
	9.10.6.3		19
	9.4.5.3	8	
40		/	
11	7.2.2.1		6
	9.2.3.4		9
	9.9.3.3		11
	9.1.3.3		6
32		/	
12	7.5.8.3		15
	9.1.3.2		4
	9.1.2.2		6
	9.1.3.2		4
6		/	
13	5.2.1.4		22
	9.8.1.1		7
	9.1.5.3	6	
35		/	
14	8.4.16.1		14
	9.4.2.2		7
	9.10.2.4		15
	9.1.4.6	10	
46			
<b>Total K = 488</b>			

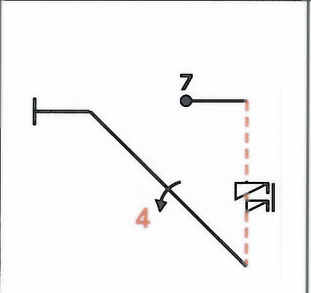
SEQUENCE APPROVED

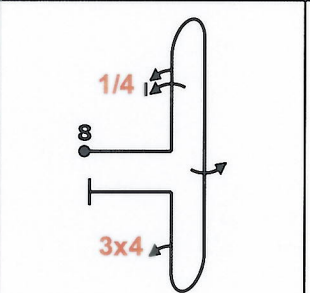
JURY S  
 16/8/24  
 16.00

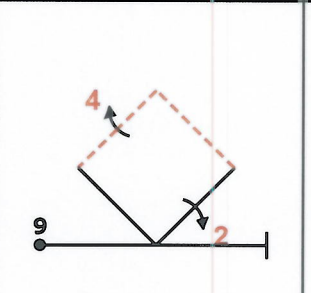
Proposal "O" ROU Pilot  
 A/C

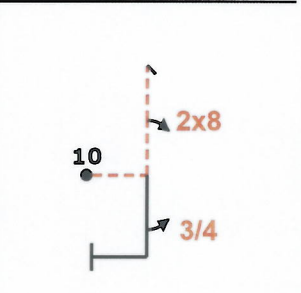
 <p><b>Fig A</b> 8.8.5.1(21) 9.9.1.3(15) 9.10.5.3(13) 9.4.1.2(9) <b>K: 58</b></p> <p><b>ROU</b></p> 	 <p><b>Fig B</b> 8.6.4.1(14) 9.10.6.2(19) 9.9.8.4(13) 9.1.3.7(11) 9.1.3.5(9) <b>K: 66</b></p> <p><b>ESP</b></p> 	 <p><b>Fig C</b> 8.4.16.1(14) 9.4.2.2(7) 9.10.2.4(15) 9.1.4.6(10) <b>K: 46</b></p> <p><b>LUX</b></p> 	 <p><b>Fig D</b> 7.2.2.1(6) 9.2.3.4(9) 9.9.3.3(11) 9.1.3.3(6) <b>K: 32</b></p> <p><b>ITA</b></p> 	 <p><b>Fig E</b> 7.8.3.4(19) 9.1.3.4(8) 9.4.2.3(10) 9.9.2.3(13) 9.1.2.5(11) 9.8.2.1(5) <b>K: 66</b></p> <p><b>HUN</b></p> 
 <p><b>Fig F</b> 8.4.1.1(13) 9.10.6.3(19) 9.4.5.3(8) <b>K: 40</b></p> <p><b>SUI</b></p> 	 <p><b>Fig G</b> 1.2.6.3(15) 9.11.1.6(3) 9.4.2.4(13) <b>K: 31</b></p> <p><b>GER</b></p> 	 <p><b>Fig H</b> 8.8.2.1(19) 9.1.1.5(14) 9.1.5.4(8) 9.4.1.3(12) <b>K: 53</b></p> <p><b>FRA</b></p> 	 <p><b>Fig I</b> 7.4.5.1(15) 9.2.2.4(11) 9.4.4.4(11) <b>K: 37</b></p> <p><b>USA</b></p> 	 <p><b>Fig J</b> 5.2.1.4(22) 9.8.1.1(7) 9.1.5.3(6) <b>K: 35</b></p> <p><b>CZE</b></p> 